

Volume Practice Hwk

Find the volume of each figure. Round your answers to the nearest hundredth, if necessary.

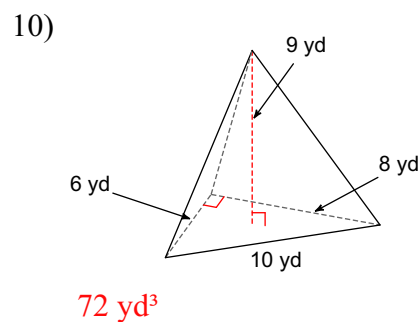

11)

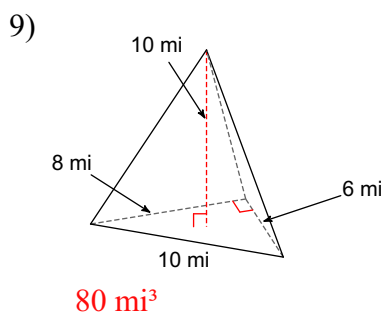
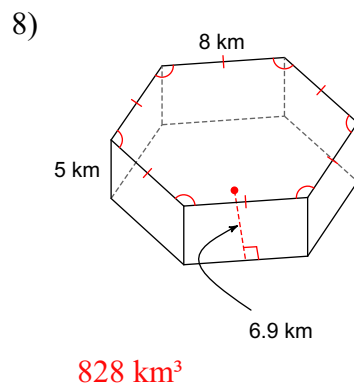
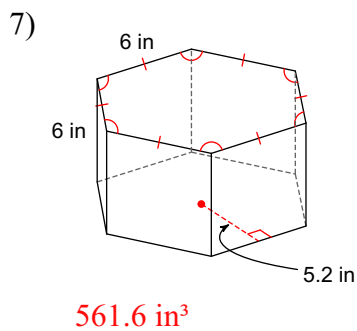
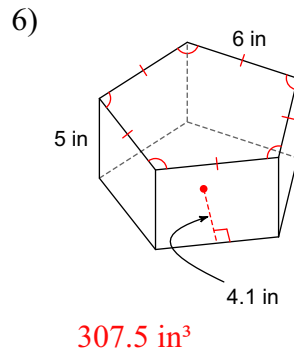
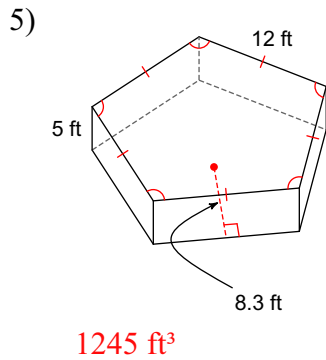
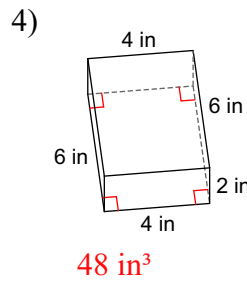
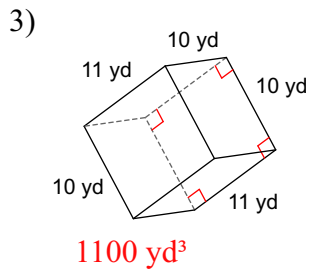
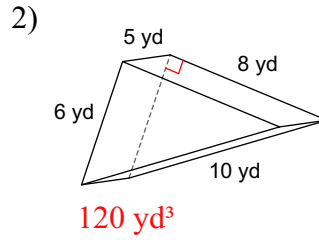
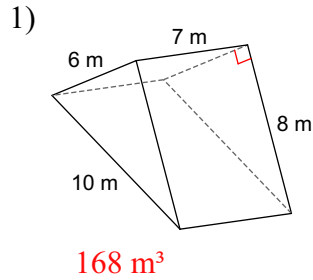
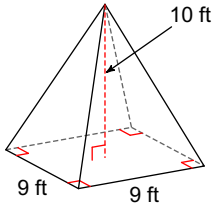

270 ft³

12)

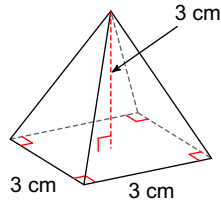

9 cm³

13)

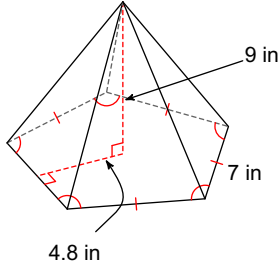

252 in³

14)

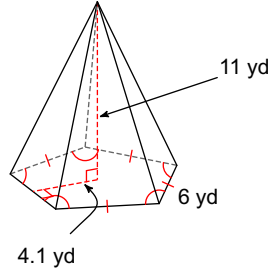

225.5 yd³

15)

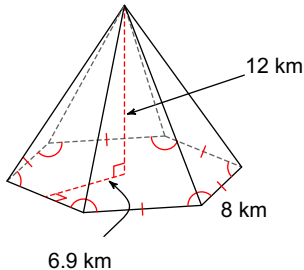

662.4 km³

16)

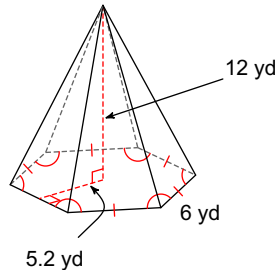

374.4 yd³

17)

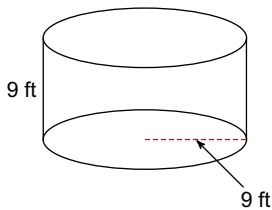

2290.22 ft³

18)

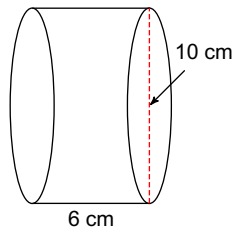

471.24 cm³

19)

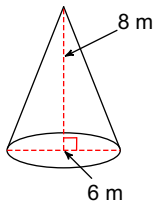

75.4 m³

20)

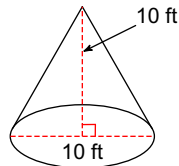

261.8 ft³

21)

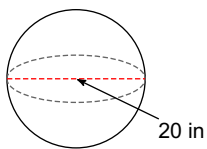

4188.79 in³

22)

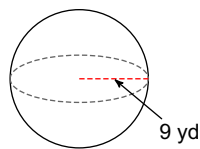

3053.63 yd³